

# Dohled optické sítě RFTM pro PON nebo P2P liniové stavby postav, zapoj a zmiz

Ing. Pavel Kosour

AKADEMIE VLÁKNOVÉ OPTIKY A OPTICKÝCH KOMUNIKACÍ<sup>®</sup>

the art of  
optical  
communication



## O čem to je?

- Masivní výstavba
- Montuje každý kdo „má ruce“ (nejsou odborníci)
- Nejsme schopni všechny vybavit odpovídajícím vybavením (cena)
- Kdybychom měřili
  - Nedokážeme měření posoudit (nejsou lidi na straně investora)
  - Každý bude měřit jinak



100% Automated testing:

✓ Feeder / F1 characterization

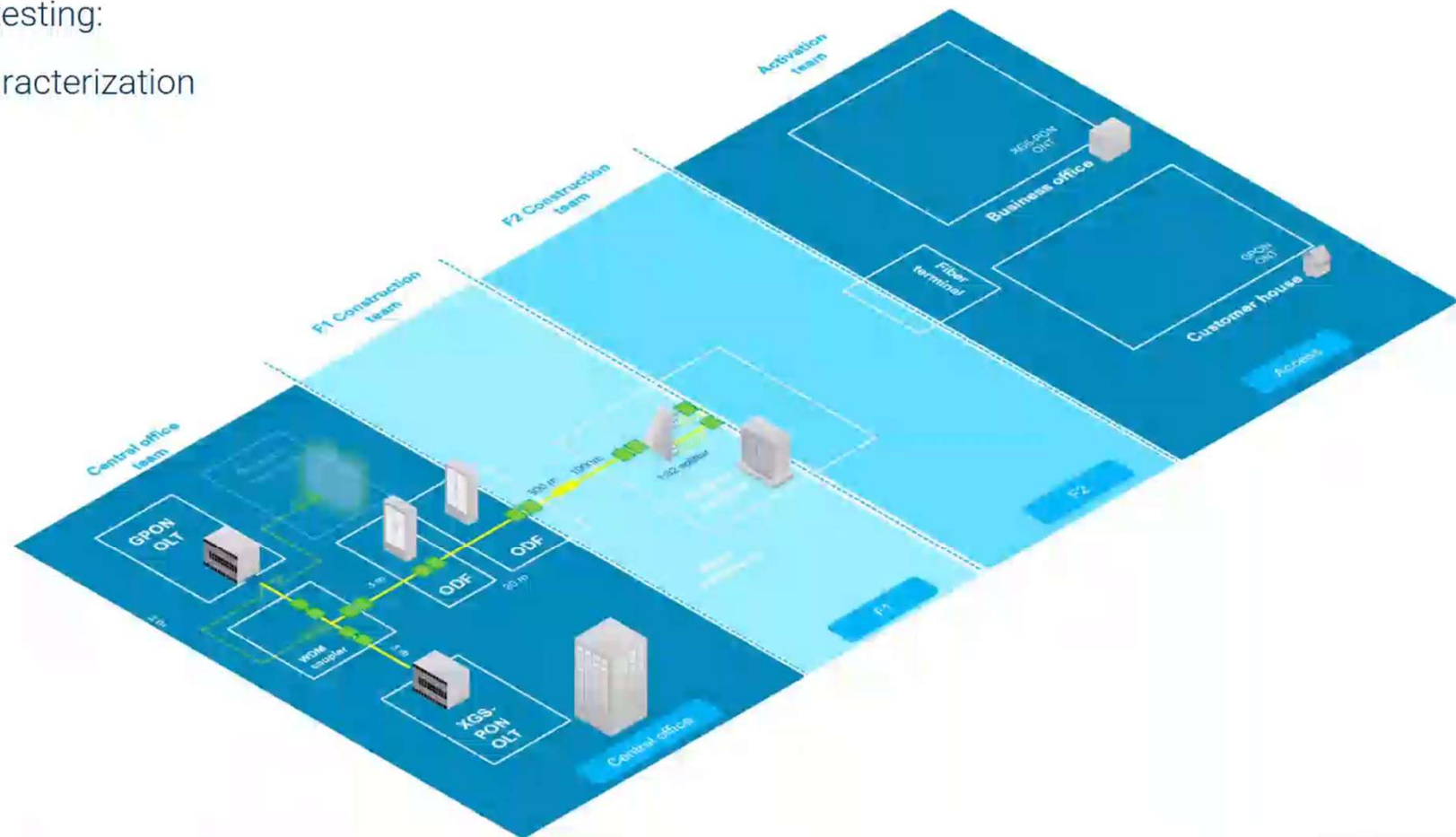

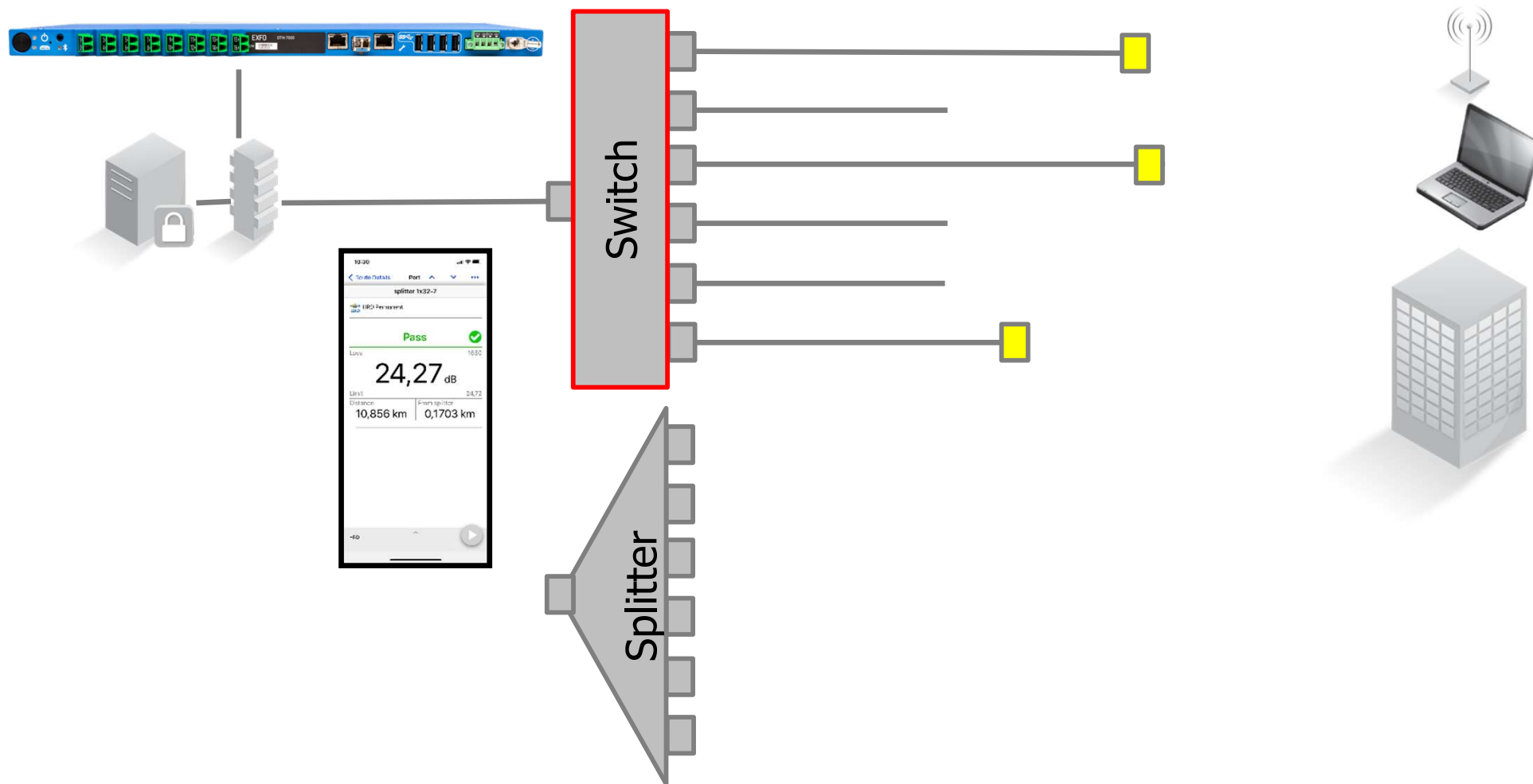

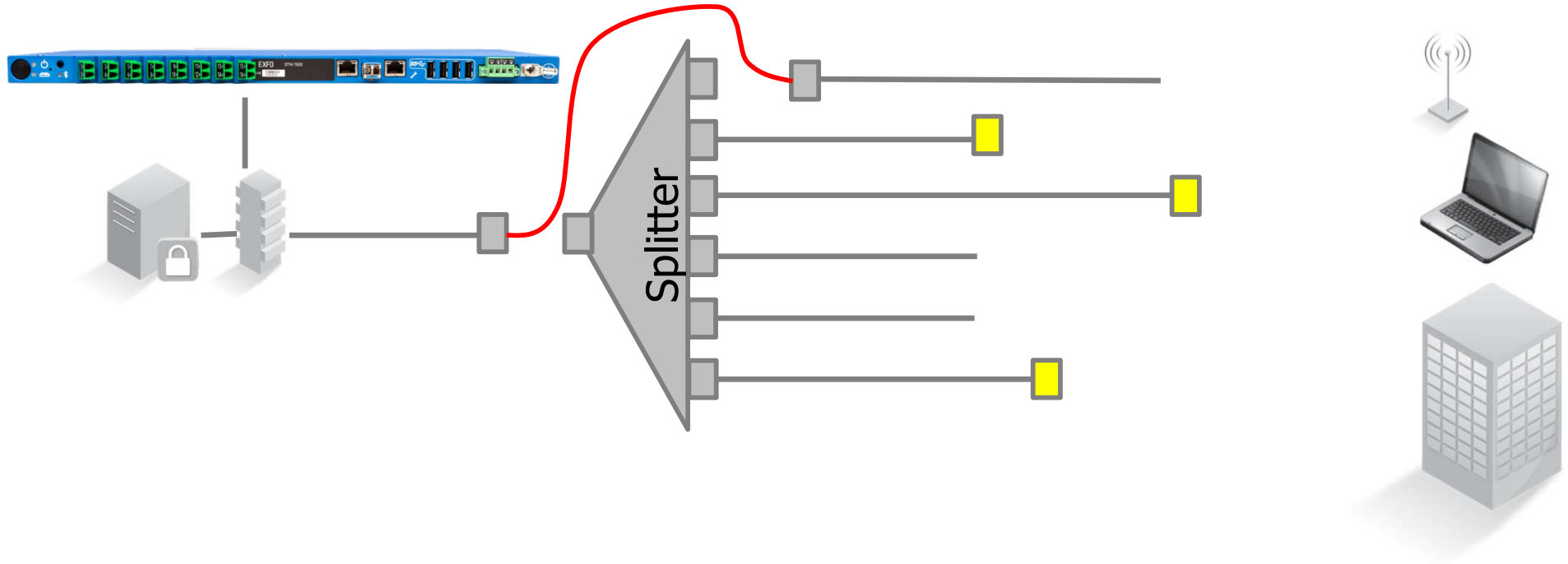
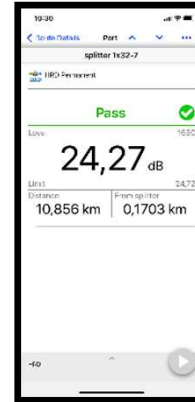

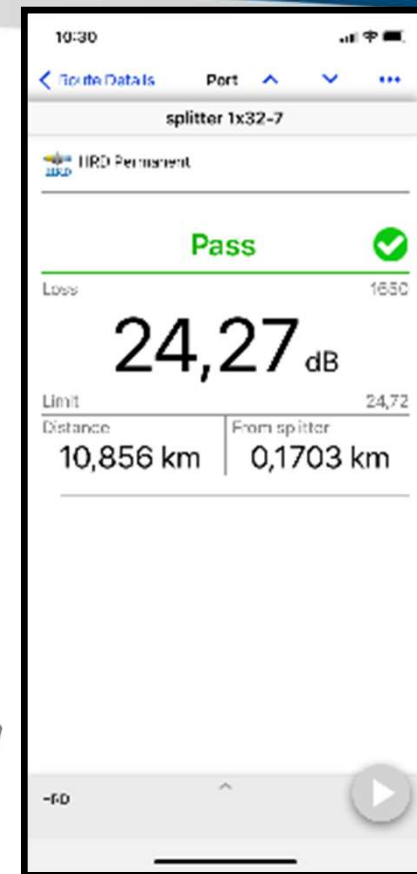
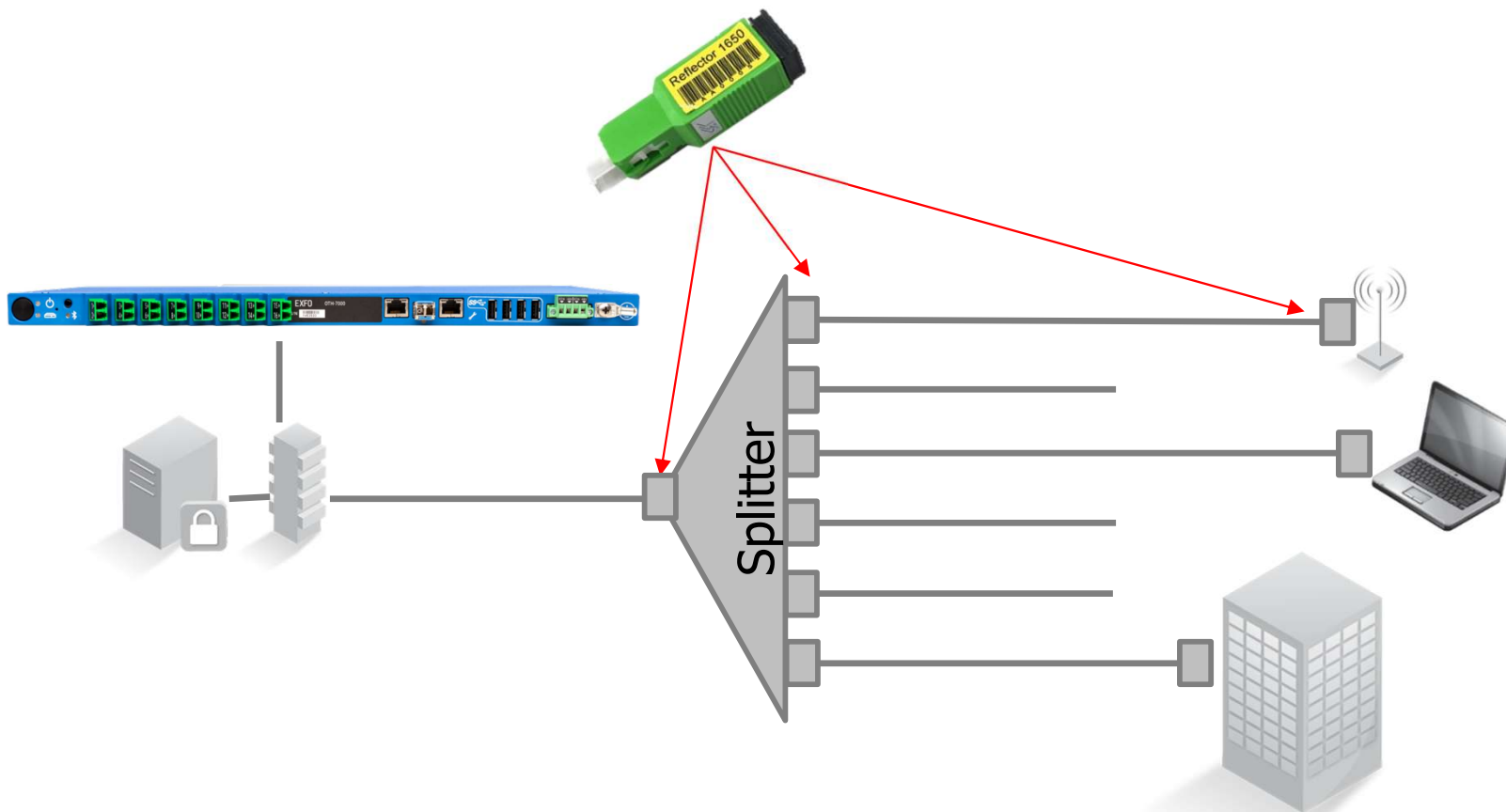

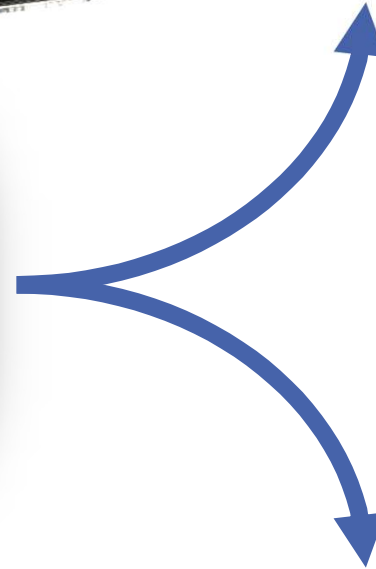

**Ing. Pavel Kosour**

pavel.kosour@profiber.eu

děkujeme

info@profiber.eu

www.profiber.eu

PROFiber Networking CZ s.r.o.  
Mezi Vodami 205/29  
143 00 Praha 4

PROFiber Networking s.r.o.  
Bernolákova 2  
917 01 Trnava

the art of  
**optical**  
communication

